

# MEA2100-System

Versatile in vitro recording system

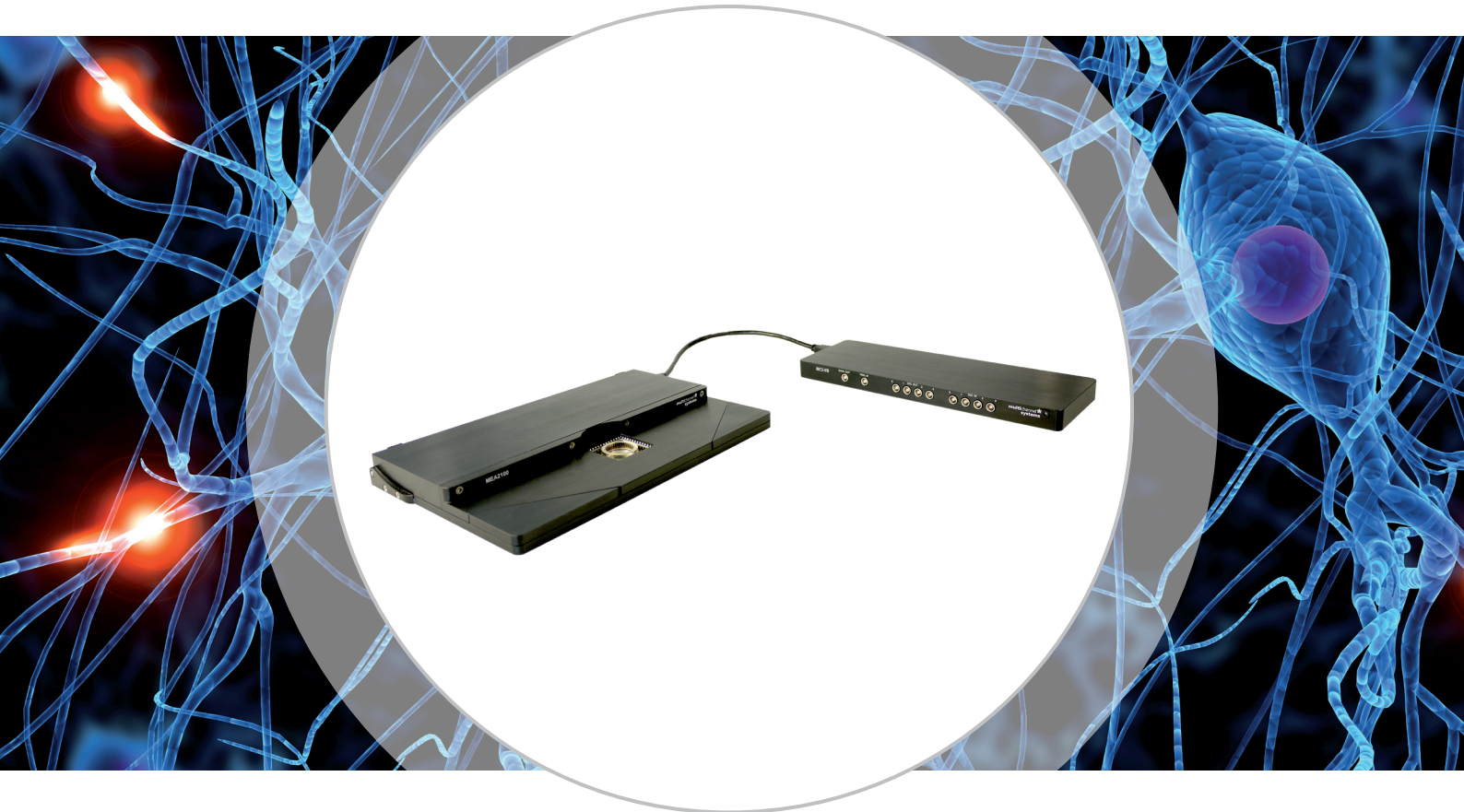

- Integrated stimulation and blanking
- Filter bandwidth adjustable via software
- 24 bit resolution
- Real-time feedback
- Up to 256 recording channels
- Variable contact units for microelectrode arrays with 60, 120 or 256 electrodes



a division of Harvard Bioscience, Inc.

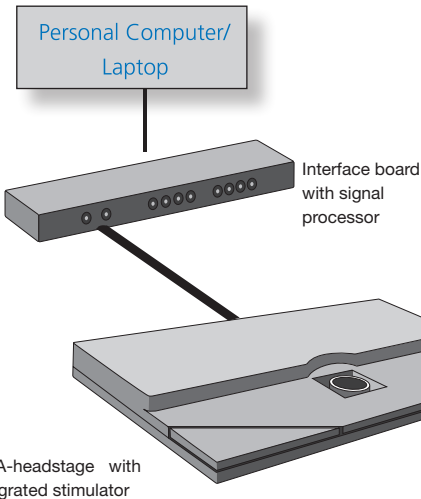

The MEA2100-System is a versatile in vitro recording system with integrated stimulation and real-time feedback, following the tradition of high-quality, low-noise amplifiers.

We provide the complete setup for your extracellular recordings from microelectrode arrays (MEAs), including everything you need for your experiment: data acquisition computer with powerful software; interface board with multiboot functionality; MEA-headstage with integrated stimulation; MEAs; as well as temperature controller and perfusion heating. Thanks to its compact design, you can position the MEA-headstage on any inverted or upright microscope. It is connected via a single eSATA cable to the interface board, which offers various analog inputs and digital in-/outputs for synchronization with other instruments.

### Variable contact unit

The main advantage of the MEA2100-System is its flexibility. Multi Channel Systems offers various contact units for the MEA-headstage. Variants for one 60-electrode MEA, one 120-electrode MEA, one 256-electrode MEA or even two 60-electrode MEAs are available. The contact unit of the MEA-headstage can be changed according to your experimental needs. The rest of the setup is not affected, so changing the contact unit is simple, quick, and cost-effective.

- 60 channels
- 120 channels
- 256 channels

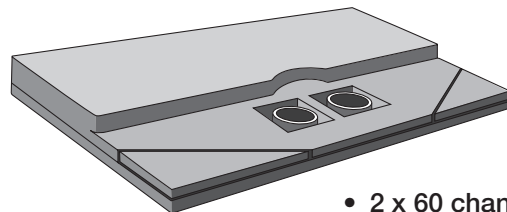
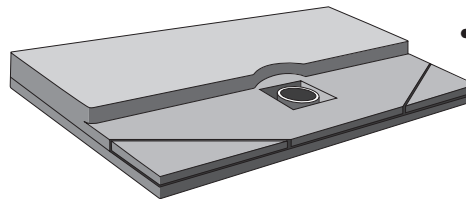

- 2 x 60 channels

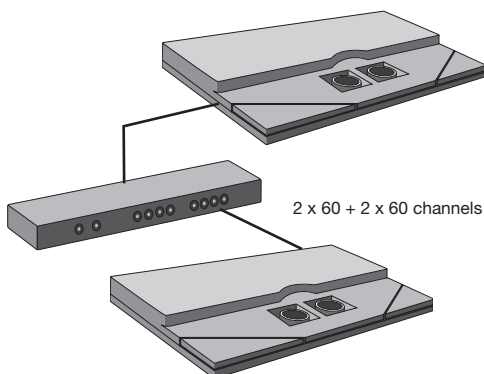
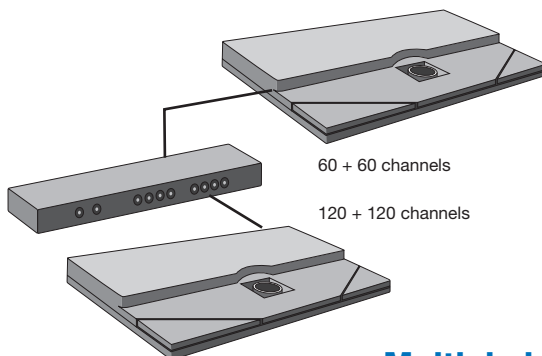

### Multiple headstages

The flexibility of the MEA2100-System is also reflected in the possibility to connect two MEA-headstages to one interface board. This way, you can record from up to 240 channels. By using two headstages with two 60-electrode MEAs each, you have a four-fold system and increased throughput. The headstages are controlled independently by opening multiple instances of the data acquisition software. Larger cell structures such as the *Xenopus* oocyte. Solutions are delivered through 1.0 mm ID square tubes (SG1000-5) with barrel-to-barrel spacing of 1.4 mm.

## Higher throughput with flexible multi-well solutions

The MEA2100-System offers the possibility to connect two headstages to one interface board. This way, you can record from up to 240 channels. For example, you can connect two headstages for two 60-electrode MEAs each. If four 6-well MEAs are used in two headstages, it is possible to record from 24 wells in parallel. However, you are not limited to multi-well solutions. By using different MEAs, the setup can be optimized for a completely different application within seconds.



## 6-well MEA

In the 6-well microelectrode array, the 60 recording electrodes are divided into 6 independent wells with 9 recording electrodes each. Independent measurements can be performed in each well.

These arrays are ideal for toxicology, stem cell research, and safety pharmacology, as they considerably increase the throughput of your system. A maximum of 24 wells on four MEAs can be recorded in parallel with one MEA2100-System.

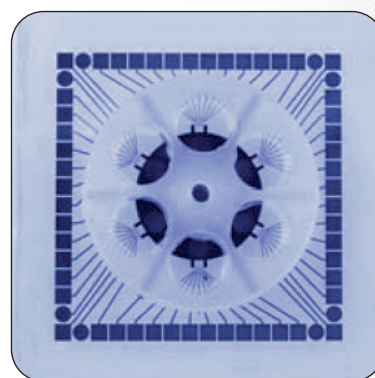

## Interface board 3.0 multiboot

The MCS-IFB 3.0 multiboot is a new generation of interface boards, which enables you to operate a wide range of MCS in vitro and in vivo headstages: MEA2100-HS, MEA2100-Mini-HS, MEA2100-Beta-Screen, Multiwell-MEA-HS, CMOS-MEA-HS, W2100-RE, and ME2100-HS. This allows cost-effective combinations with only one interface board and multiple recording systems.



As a result, you have even more flexibility in switching between possible configurations for your specific research needs. You can establish your experiments for example on 60, 120 or 256 electrodes with the MEA2100-System, then purchase the Multiwell-headstage and start high throughput screening.

It is also possible to use the same interface board for in vitro MEA experiments and wireless in vivo recordings. This new interface board provides flexibility at its best.

## Stimulation integrated in MEA-headstage

The integrated stimulus generator offers up to 3 different stimulation patterns (monophasic, biphasic, bursts) per available MEA. You can choose between current and voltage stimulation and select each electrode for stimulation. All configurations (stimulation patterns, output, and electrodes) are defined via the included Multi Channel Suite data acquisition software, so you can control all parameters of your experiment from within a single program.

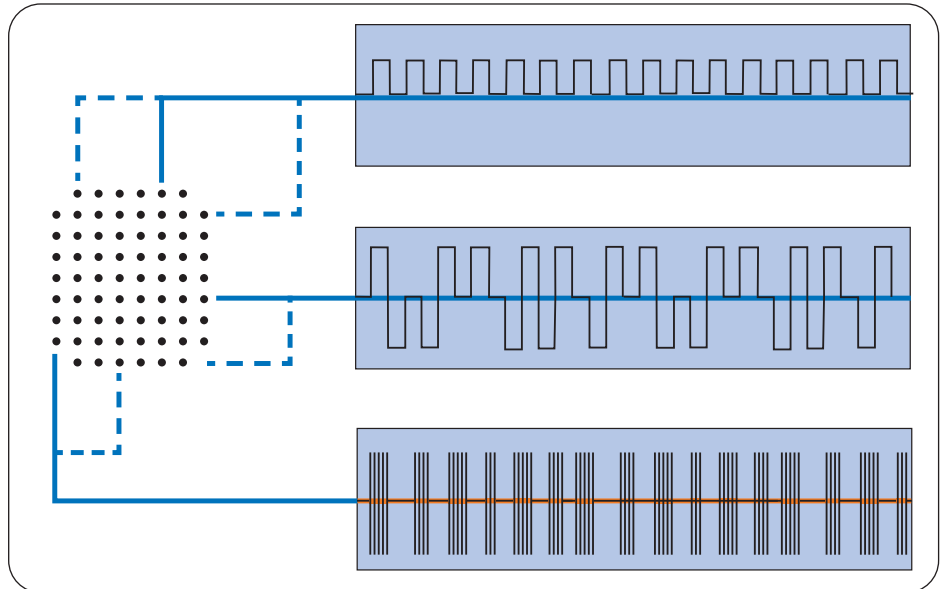

## Flexible and powerful: Multi Channel Suite

The Multi Channel Suite data acquisition and analysis program is highly adaptable with essentially limitless possibilities. Multi Channel Suite is a brand new software based on more than 20 years of experience.



## Real-time signal detection and feedback

Real-time signal detection/feedback is integrated in all MEA2100-60 and -120-Systems. It is an essential feature if you need fast and predictable reactions related to recorded analog signals without time delay. Normally, the signal must be analyzed by the computer, which leads to an unpredictable time delay of the stimulus of at least 100 ms. By moving the analysis from the PC to the DSP (Digital Signal Processor) integrated in the interface board of the MEA2100-System, the detour is obsolete and the time delay reduced well below 1 ms. Simply define the condition for the feedback and download it to the interface board (1). During recording (2), the DSP filters the data and detects spikes (3), checking whether your condition is fulfilled. When a designated event is detected, the integrated stimulus generator generates the stimulus pulse (4).



## 60-electrode MEAs: The widest range

MEAs with 60 electrodes are available in many variations. They are offered as standard glass as well as perforated MEAs, with different electrode materials (titanium nitride, gold) and in various layouts. You can choose between different electrode diameters and spacings, 8x8 or 6x10 grid, or select a high density layout. These MEAs are also available as “ThinMEAs”, which are as thin as a coverslip (180  $\mu\text{m}$ ). This makes them ideal whenever high resolution imaging is combined with MEA technology.

In this range, you will definitely find the right MEA for your application. If you need any help in selecting the most appropriate type, please contact our support team.

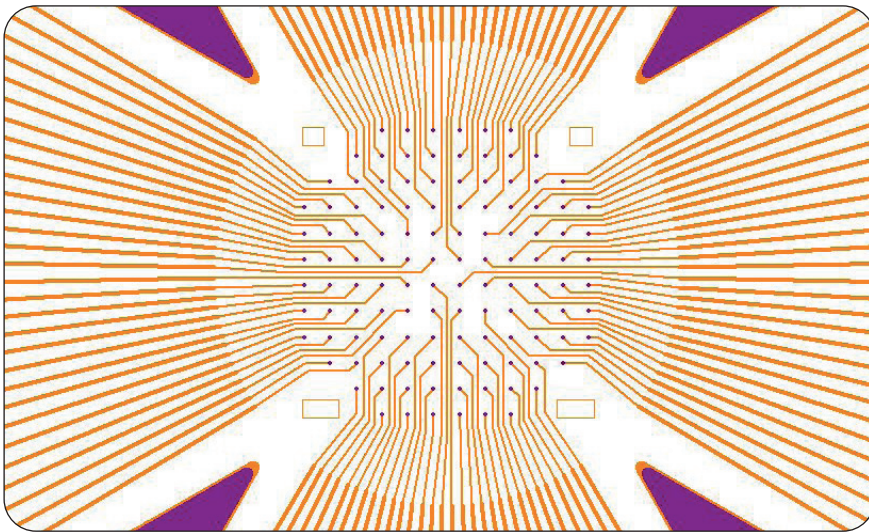
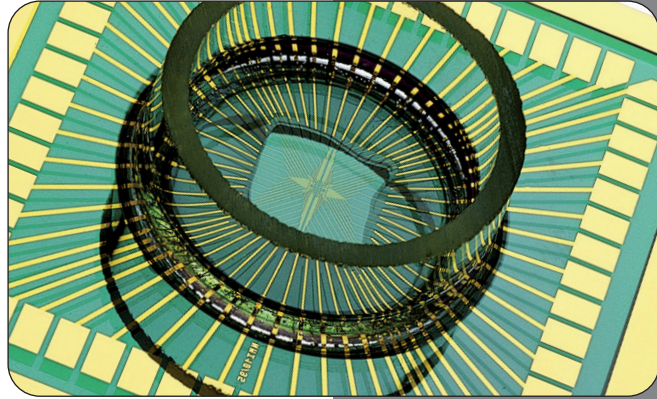

## MEAs with 120 electrodes

The MEA2100-System is the only MEA-System that can be operated with MEAs with 120 electrodes. They are arranged in a 12x12 grid, sparing 6 electrodes in each corner. Any electrode is selectable for stimulation via the included software. Just click on the respective electrode and it will be used for stimulation.

Currently, 120MEAs are available with 30  $\mu\text{m}$ , 100  $\mu\text{m}$ , 200  $\mu\text{m}$  or 1000/1500  $\mu\text{m}$  electrode spacing and 10  $\mu\text{m}$  or 30  $\mu\text{m}$  electrode diameter. There are both standard glass and perforated MEAs. Other configurations are under development. Please contact us if you need a custom layout.

## MEAs with 256 electrodes

MEAs with 256 electrodes are arranged in a 16x16 grid. There are MEAs with 30  $\mu\text{m}$ , 60  $\mu\text{m}$ , 100  $\mu\text{m}$  or 200  $\mu\text{m}$  electrode spacing and 8  $\mu\text{m}$ , 10  $\mu\text{m}$  or 30  $\mu\text{m}$  electrode diameter available. 256MEAs are also available as ThinMEAs, which are ideally suited for high resolution imaging. To increase throughput further, there are also 6- and 9-well MEAs available.

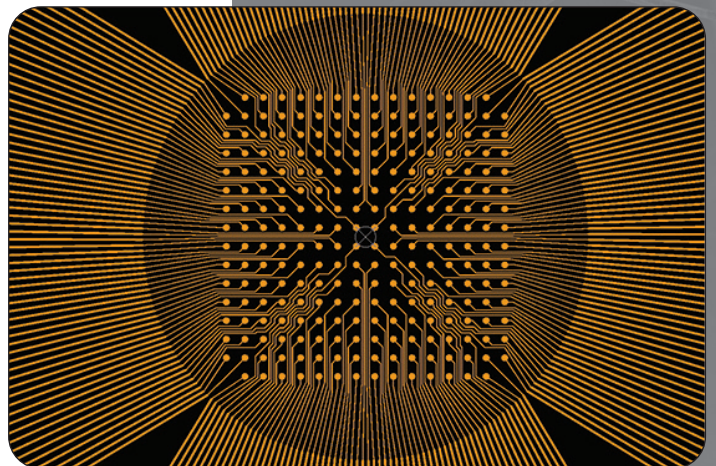

SPECIFICATIONS	
<b>General characteristics:</b>	
<b>Dimensions (W x D x H)</b>	Headstage: 250 mm x 151 mm x 25 mm Interface board: 250 mm x 83 mm x 25mm
<b>Weight</b>	Headstage: 1.0 kg Interface board: 0.3 kg
<b>Amplifier:</b>	
<b>Data resolution</b>	24 bit
<b>Number of recording channels</b>	60-252 (depending on headstage type)
<b>Bandwidth</b>	0.1 Hz to 10 kHz
<b>Stimulus generator:</b>	
<b>Number of stimulation channels</b>	3 independent patterns per MEA slot (2 for MEA2100-HS256)
<b>Available waveforms</b>	rectangular, sine wave, arbitrary
<b>Output current</b>	± 1.5 mA
<b>Output voltage</b>	± 12 V

SPECIFICATIONS	
<b>Data converter and USB interface:</b>	
<b>Control interface</b>	USB 3.0
<b>Sampling rate per channel</b>	up to 50 kHz per channel
<b>Heating element and temperature sensor:</b>	
<b>Temperature accuracy</b>	± 0.1 °C
<b>Temperature sensor type</b>	PT 100 with 4 wire connection
<b>Software:</b>	
<b>Operating system</b>	Windows 10, 8.1 or 7 (64 bit) English and German versions are supported
<b>Multi Channel Experimenter</b>	Version 2.7.3 and higher
<b>Multi Channel Analyzer</b>	Version 2.7.3 and higher
<b>Multi Channel DataManager</b>	Version 2.1.0 and higher
<b>Data export</b>	HDF5 (*.h5) (Matlab, Python, R, etc.), NeuroExplorer (*.nex), Spike2 (*.smr), ASCII file (*.txt), European Data Format (*.EDF+)

Product information is subject to change without notice. Products that are referred to in this document may be either trademarks and/or registered trademarks of the respective owners. The publisher and the author make no claim to these trademarks.

© February 2020  
Multi Channel Systems MCS GmbH



The Smart Source for All Your Ephys Needs

[www.smart-ephys.com](http://www.smart-ephys.com)

**Americas**

us-sales@smart-ephys.com  
(+1) 833 668 8632

**Europe, Middle East, Africa**

sales@smart-ephys.com  
(+49) 7121 909 2525

**Asia Pacific**

apac-sales@smart-ephys.com  
(+86) 21 6226 0239

[www.multichannelsystems.com](http://www.multichannelsystems.com)